

Victor O

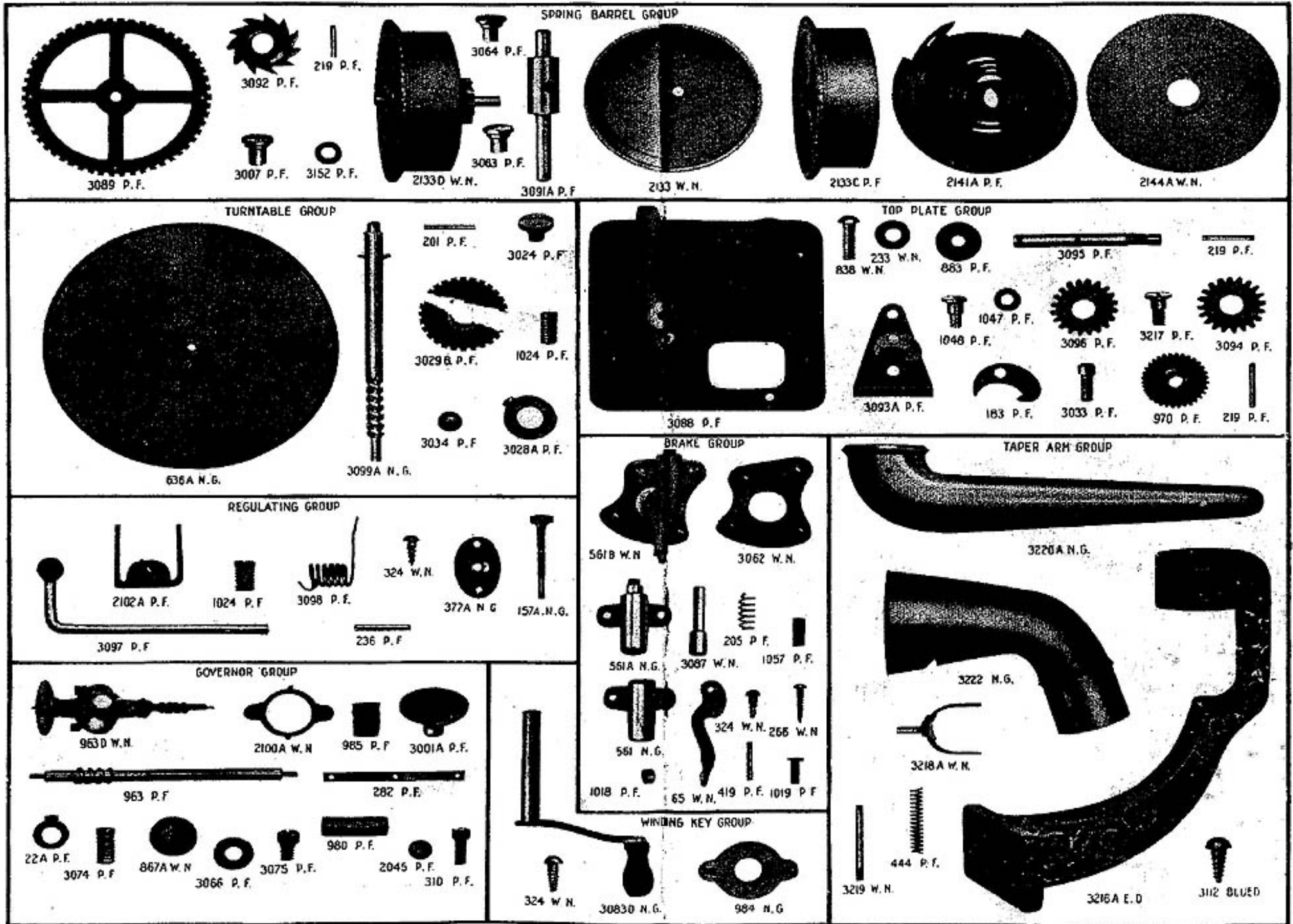

VICTOR O (Type EM)

SPRING BARREL GROUP

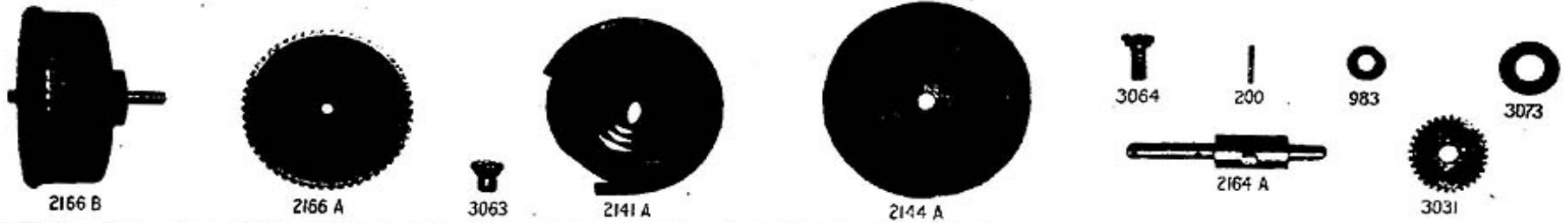

TURNTABLE GROUP

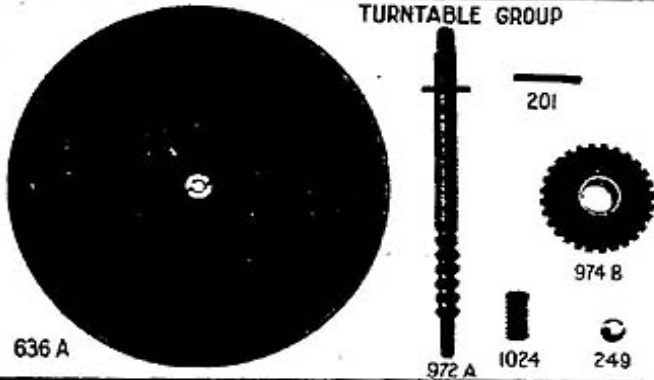

TOP PLATE GROUP

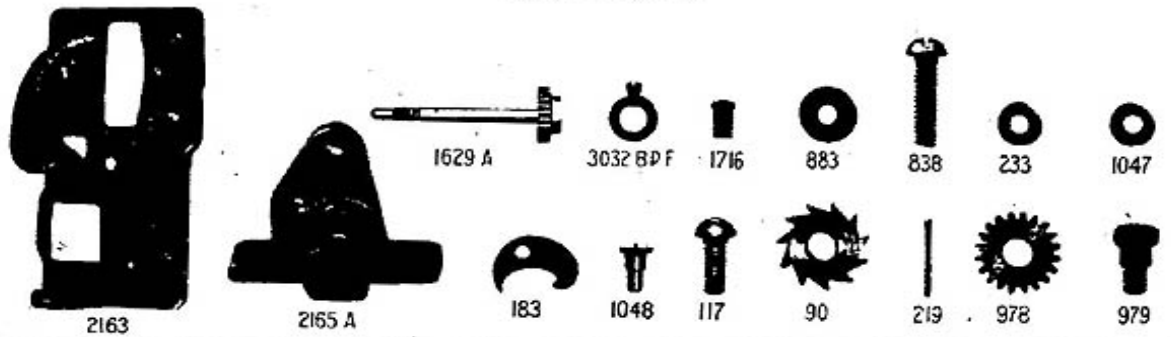

REGULATING GROUP



BRAKE GROUP



WINDING KEY GROUP

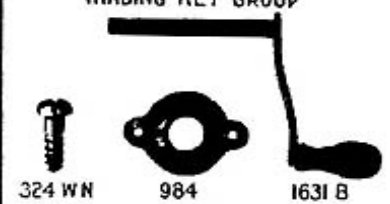

GOVERNOR GROUP

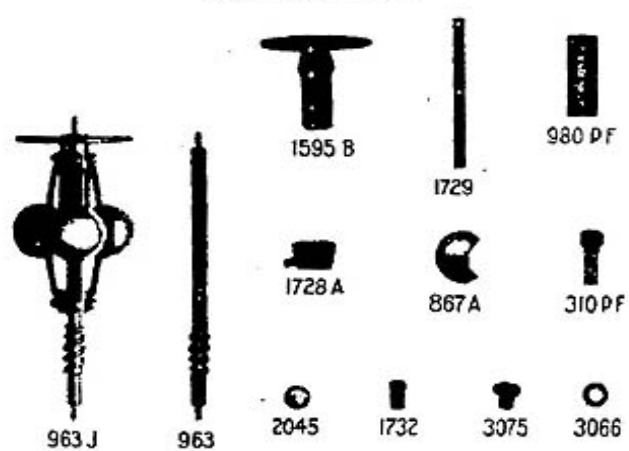

TAPER ARM GROUP

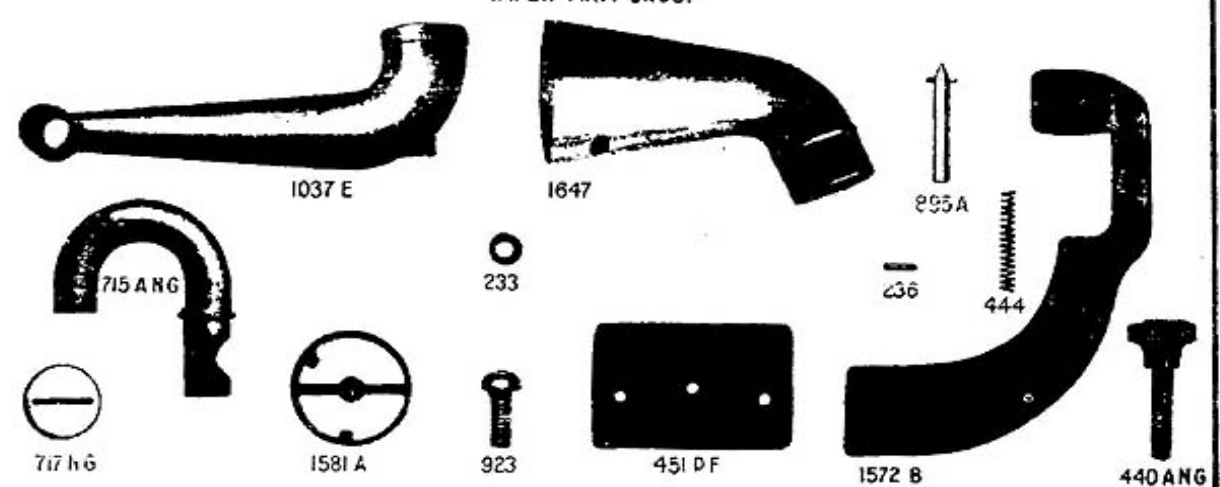

Victor I

SPRING BARREL GROUP



3089 P.F.



3092 P.F.



219 P.F.



3007 P.F.



3152 P.F.



2133D.W.N.



3064 P.F.



3063 P.F.



3098A.P.F.



2133 W.N.



2133C.P.F.



2141A.P.F.



2144A.W.N.

TURN TABLE GROUP

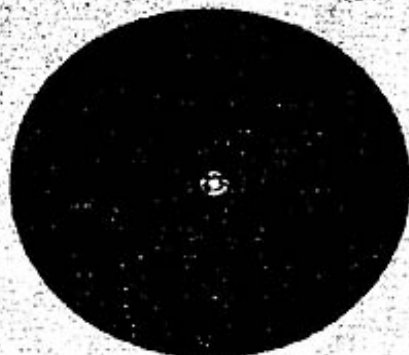

636A.N.G.



3099A.N.G.



201 P.F.



3029B.P.F.



3034 P.F.



3024 P.F.



1024 P.F.



3028A.P.F.

TOP PLATE GROUP



3088 P.F.



638 W.N.



233 W.N.



883 P.F.

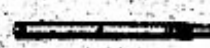

3095 P.F.



219 P.F.



1048 P.F.



1047 P.F.



3096 P.F.



3217 P.F.



3094 P.F.



3093A.P.F.



183 P.F.



3033 P.F.



970 P.F.



219 P.F.

REGULATING GROUP

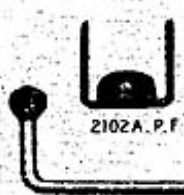

2102A.P.F.



1024 P.F.



3098 P.F.



377A.N.G.



157A.N.G.



3097 P.F.



324 W.N.



236 P.F.

BRAKE GROUP



561 B.W.N.



3062 W.N.



561A.N.G.



65 W.N.



49 P.F.



265 W.N.



1019 P.F.



1057 P.F.



3087 W.N.



205 P.F.



324 W.N.



1018 P.F.

GOVERNOR GROUP



963D.W.N.



2100A.W.N.

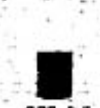

985 P.F.



3001A.P.F.

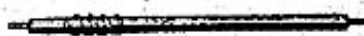

963 P.F.

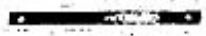

282 P.F.



22A.P.F.



3074 P.F.



867A.W.N.



3066 P.F.



3075 P.F.



980 P.F.



2045 P.F.



310 P.F.

WINDING KEY GROUP



380A.N.G.



3155A.N.G.



324 W.N.

TAPER ARM GROUP



1037A.N.G.



1040A.N.G.

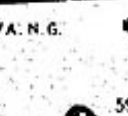

1036A.W.N.



592 N.G.



923 P.F.



451 P.F.

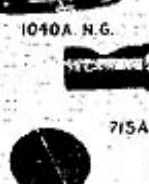

717 N.G.

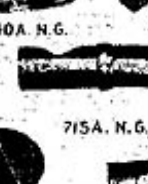

715A.N.G.



895A.W.N.



444 P.F.



235 P.F.



626D.E&D

440A.N.G.

VICTOR I (Type D)

SPRING BARREL GROUP



TOP PLATE GROUP

GOVERNOR GROUP

BRAKE GROUP

REGULATING GROUP

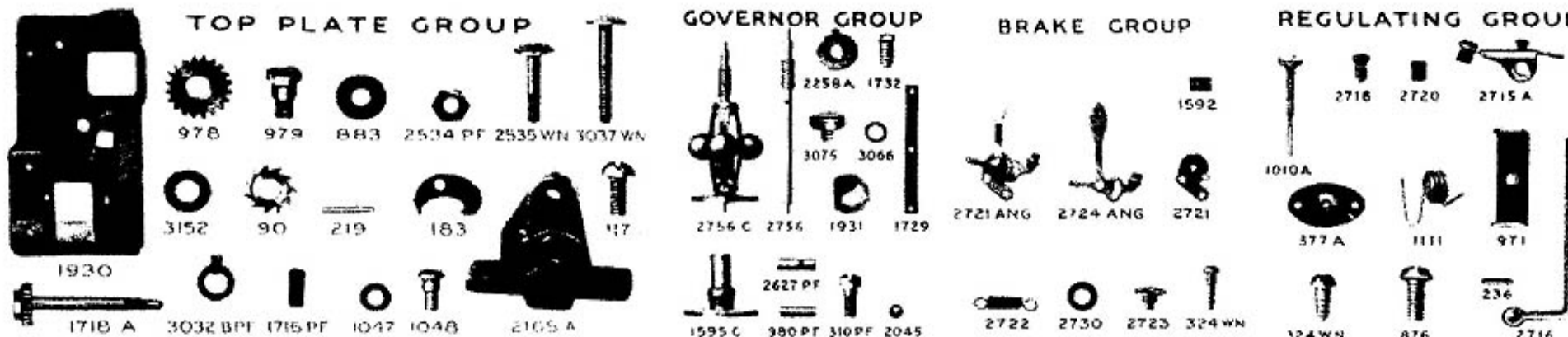

TAPER ARM GROUP

TURNTABLE GROUP

SUNDRY GROUP

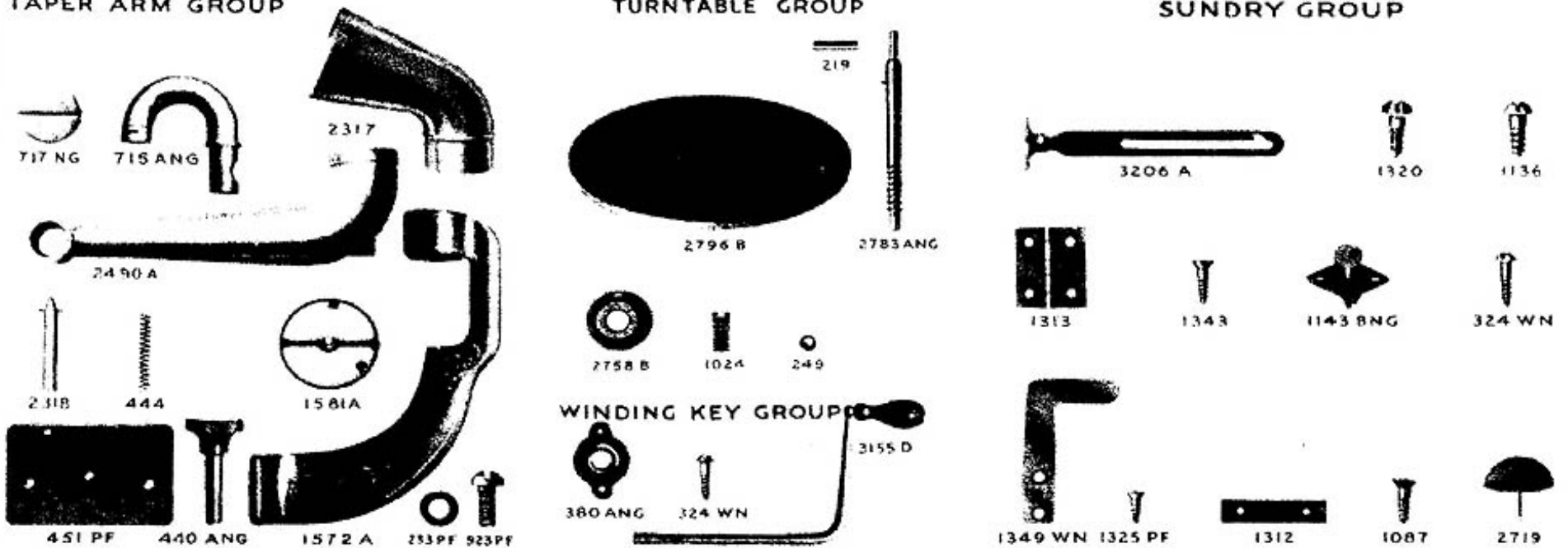

VICTOR I (Type F)

SPRING BARREL GROUP

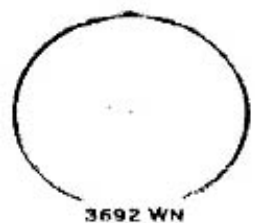

TOP PLATE GROUP



GOVERNOR GROUP

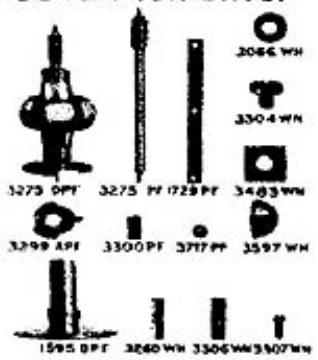

BRAKE GROUP



REGULATING GROUP

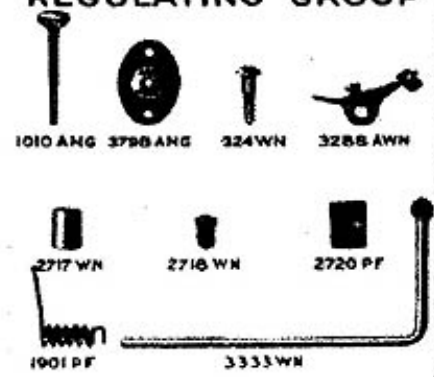

TAPER ARM GROUP

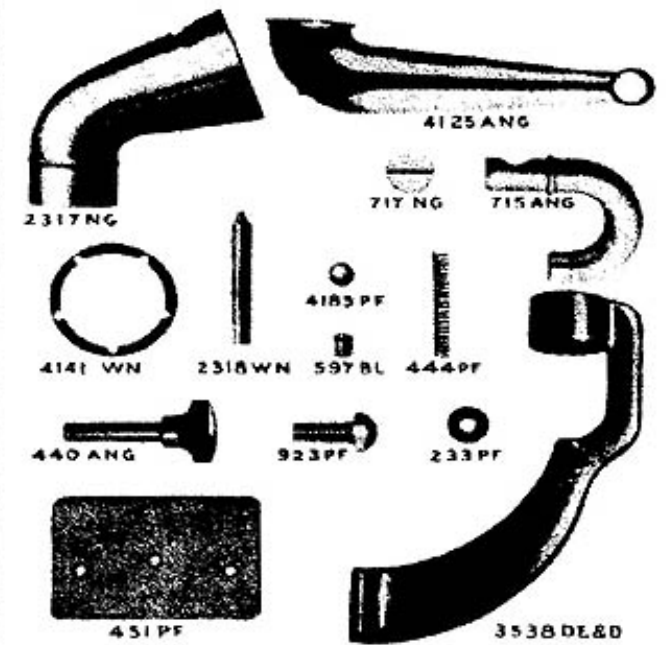

TURNTABLE GROUP

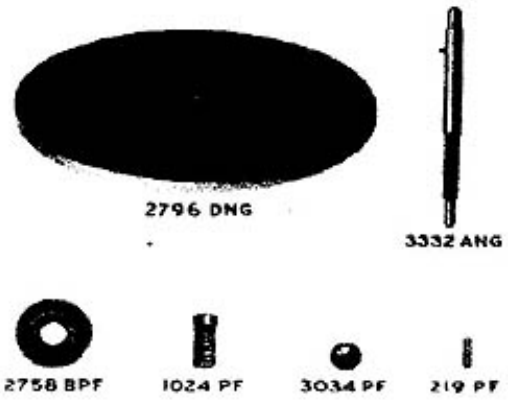

SUNDRY GROUP

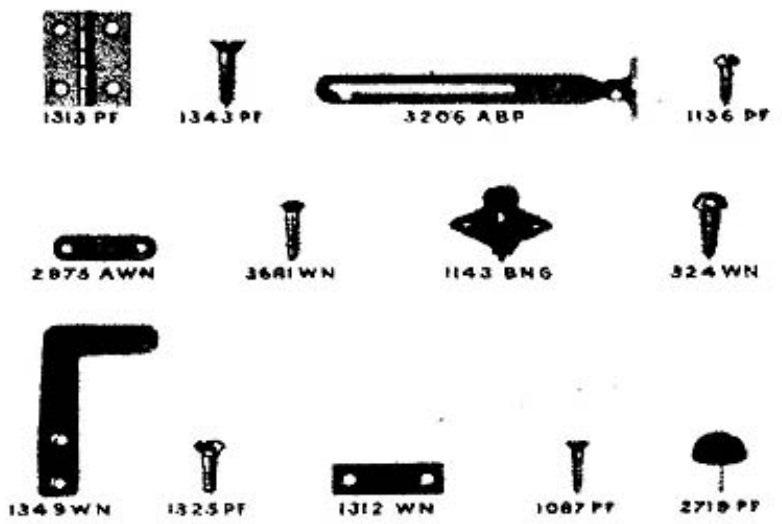

WINDING KEY GROUP

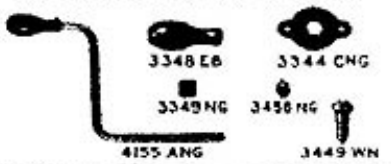

Victor II

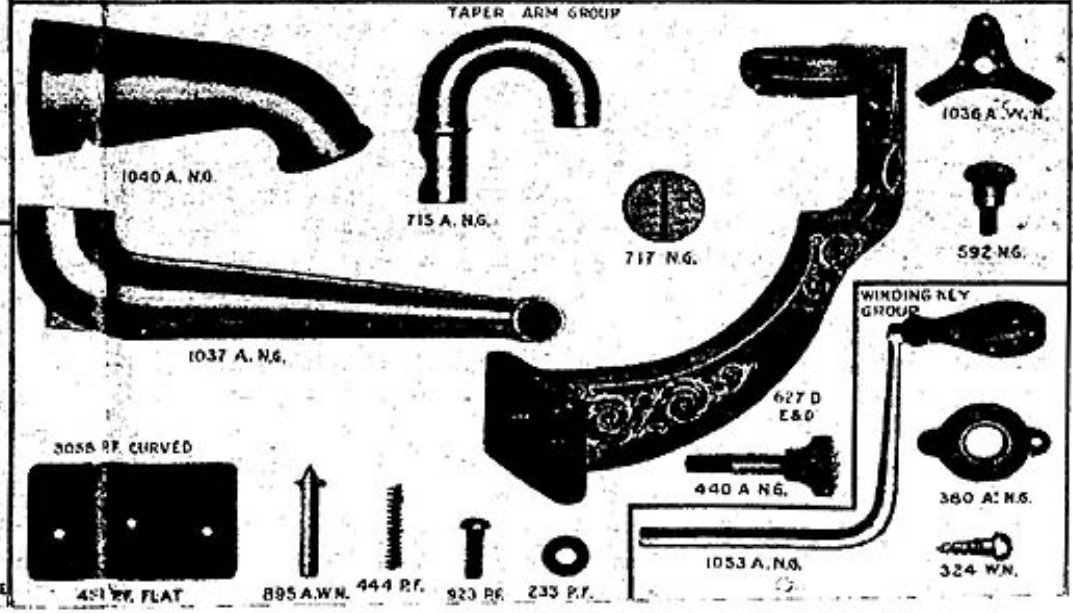
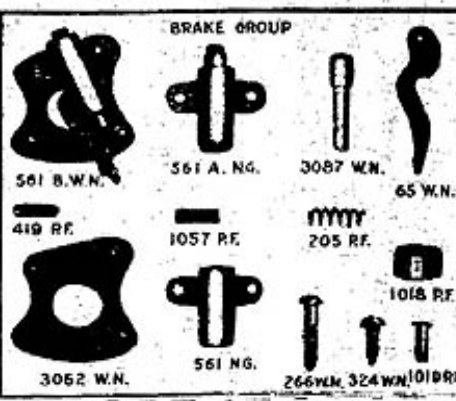
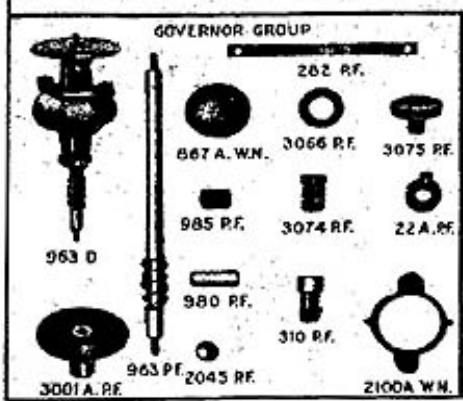
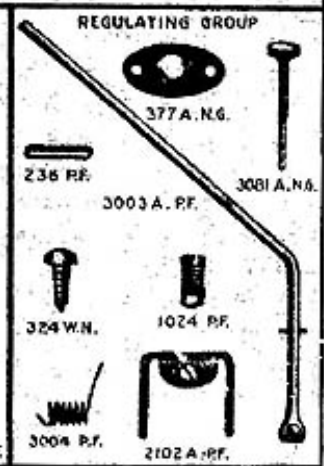
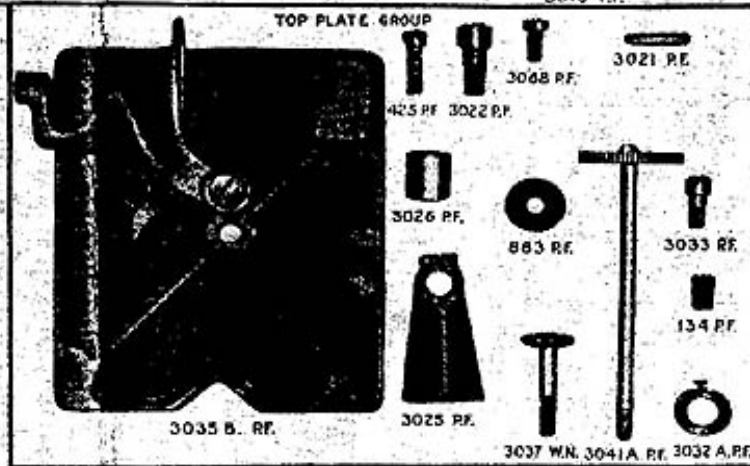
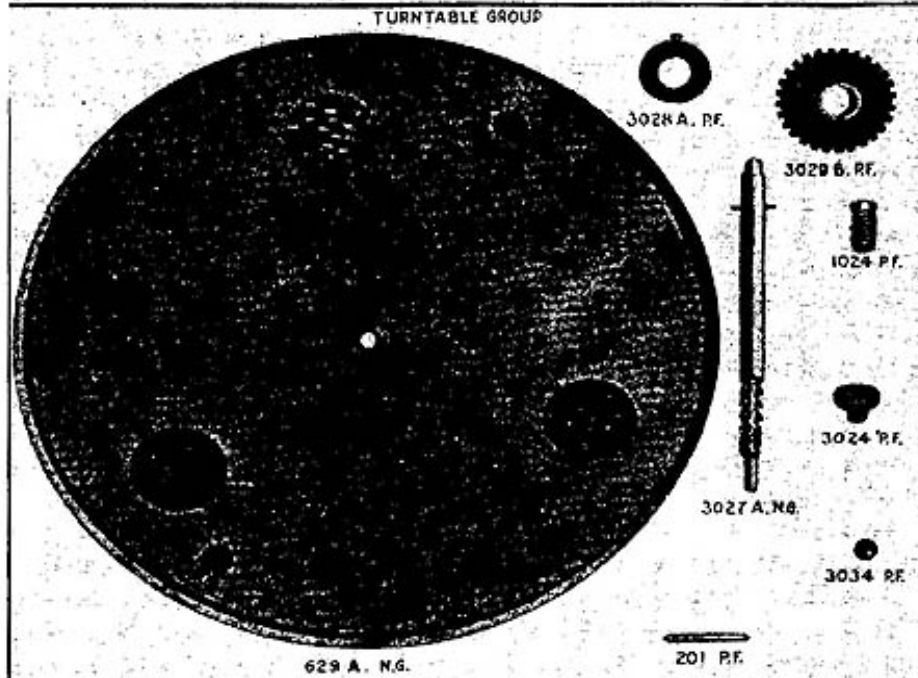
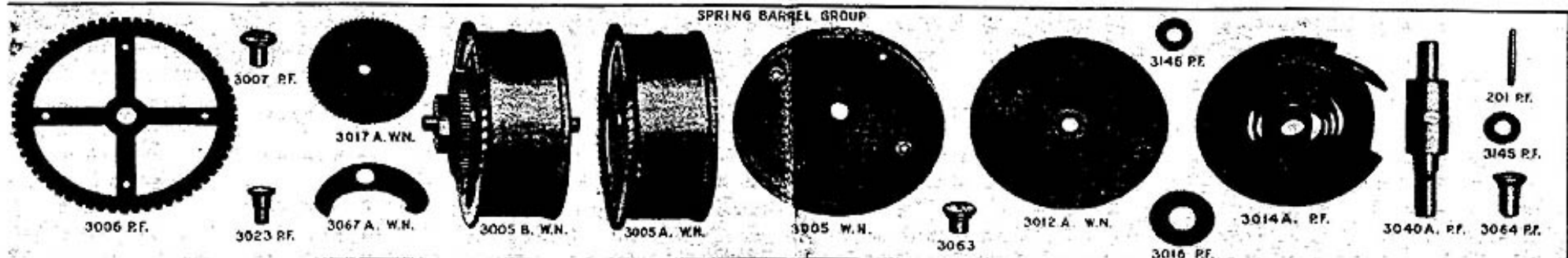

VICTOR II (Type BM)

SPRING BARREL GROUP

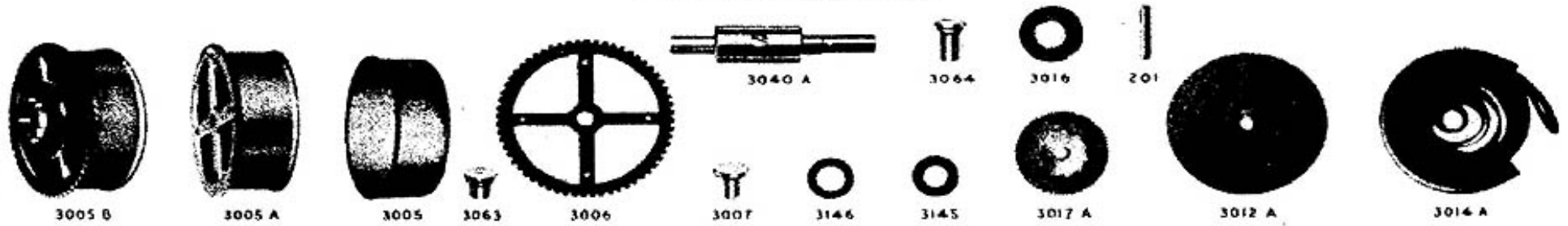

TOP PLATE GROUP



GOVERNOR GROUP



BRAKE GROUP



REGULATING GROUP

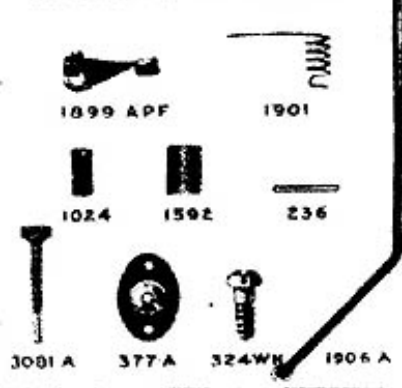

TAPER ARM GROUP

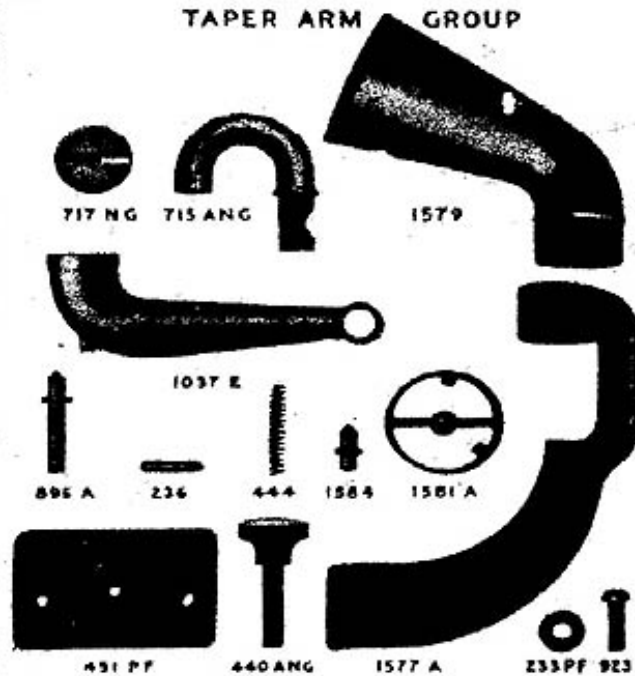

TURNTABLE GROUP

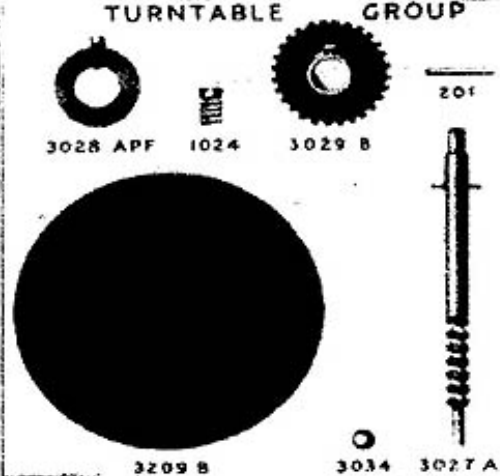

WINDING KEY GROUP



SUNDRY GROUP

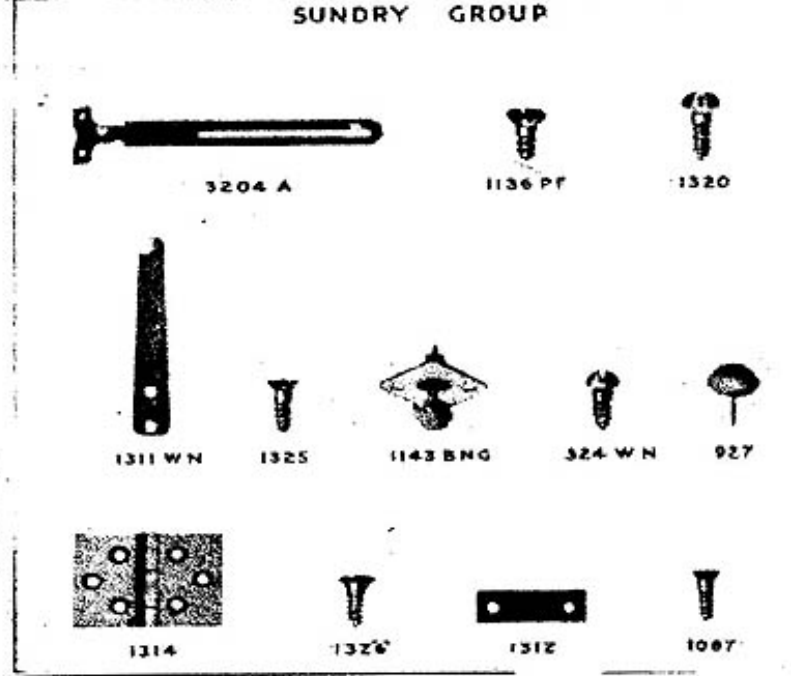

Victor III

SPRING BARREL GROUP

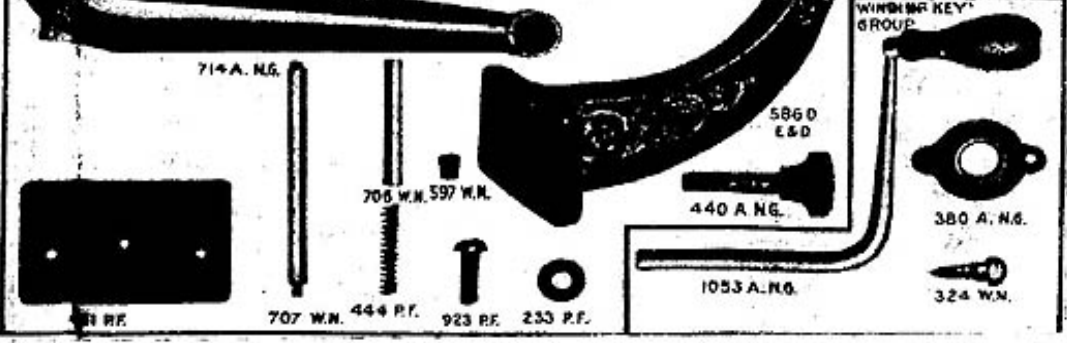
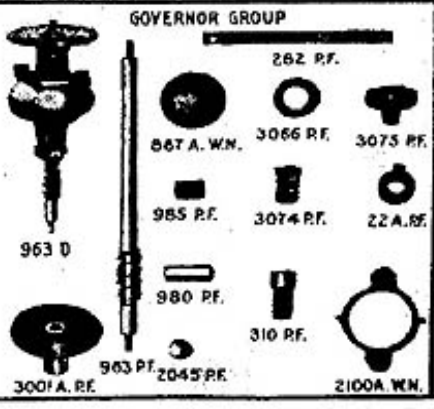
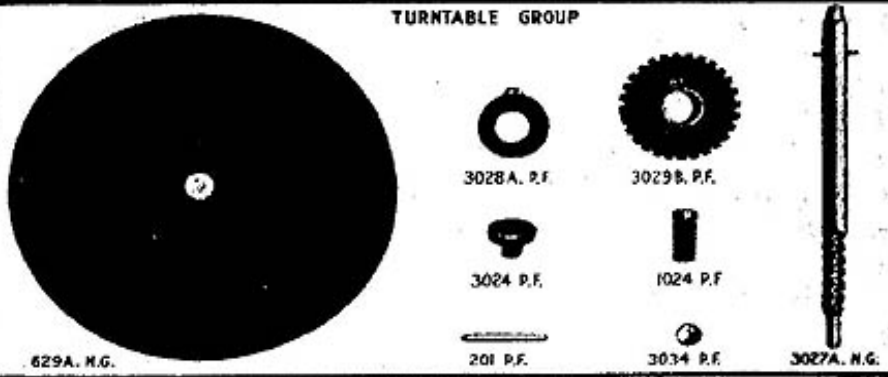
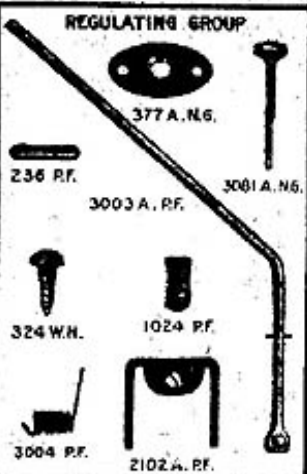
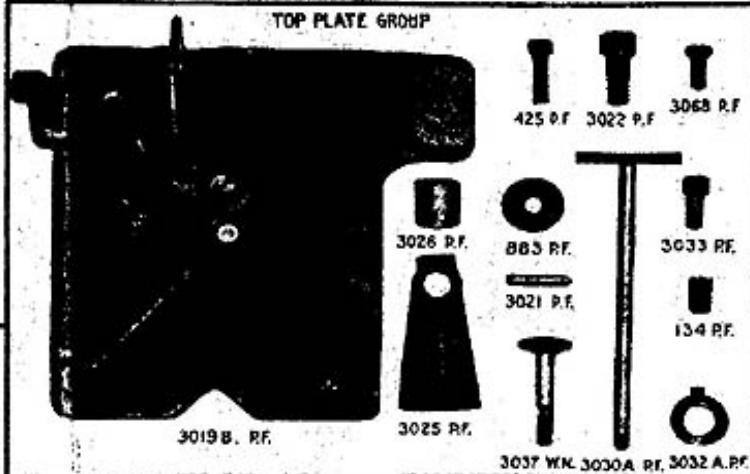
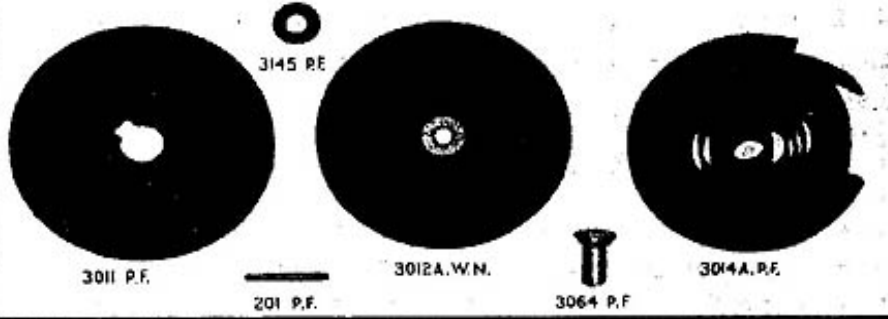
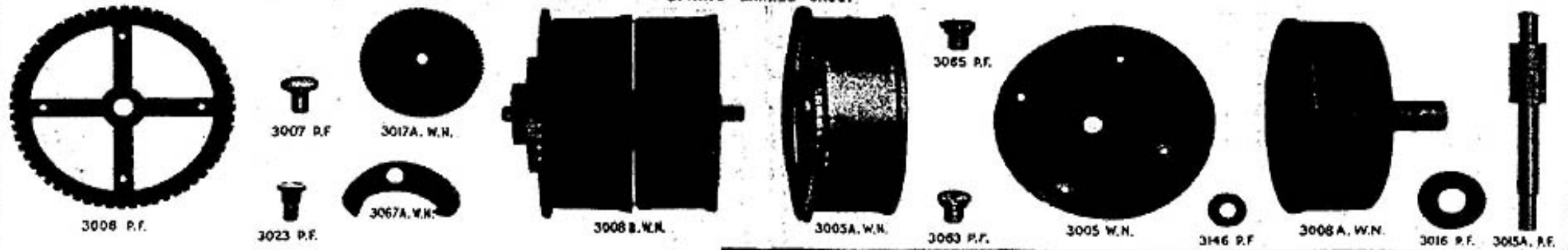

VICTOR IV (Type M)

SPRING BARREL GROUP

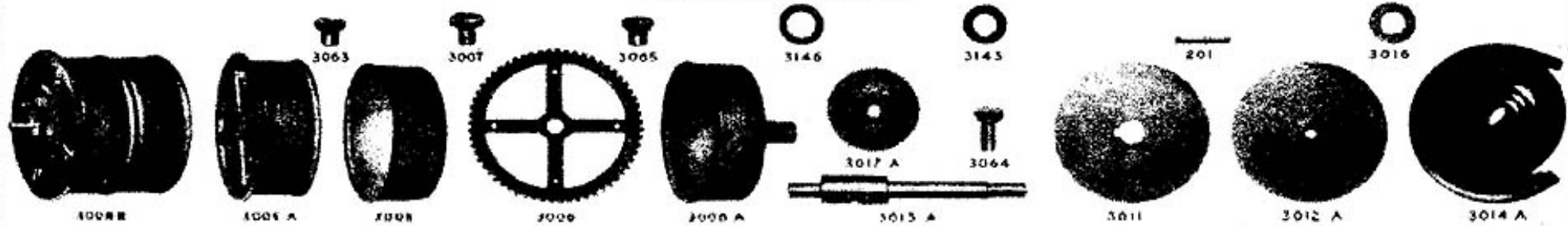

TOP PLATE GROUP

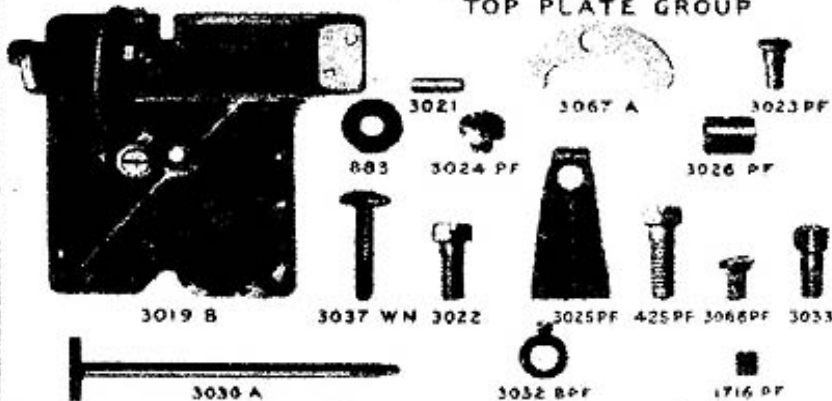

GOVERNOR GROUP

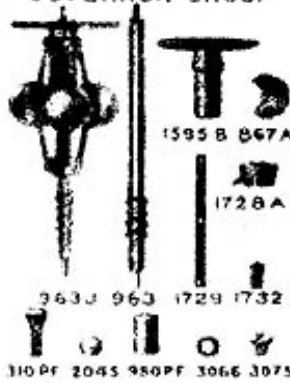

BRAKE GROUP



REGULATING GROUP



TAPER ARM GROUP

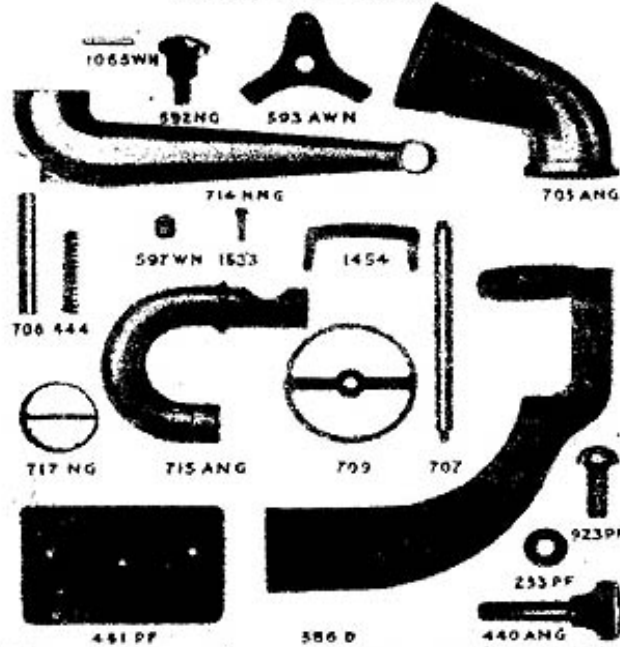

TURNTABLE GROUP

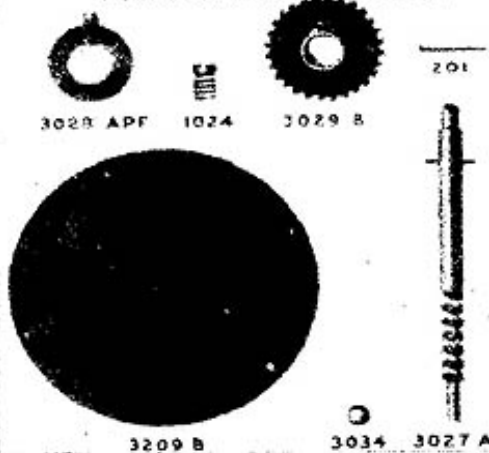

SUNDRY GROUP

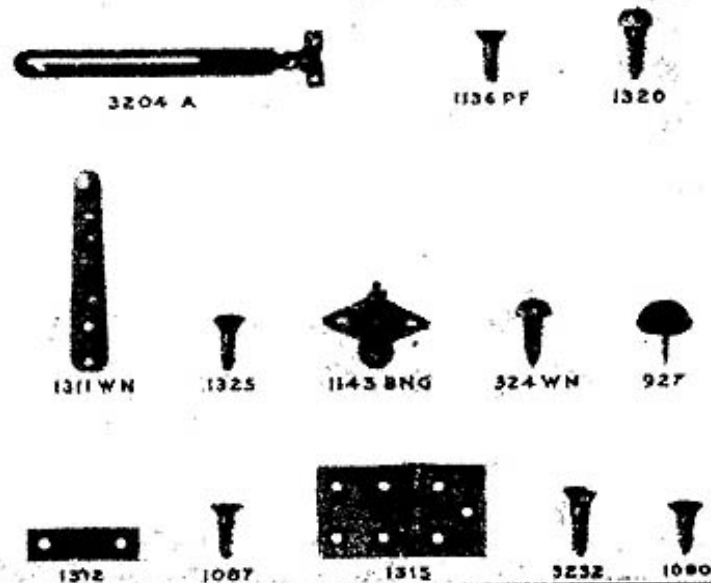

WINDING KEY GROUP



Victor Jr.

SPRING BARREL GROUP

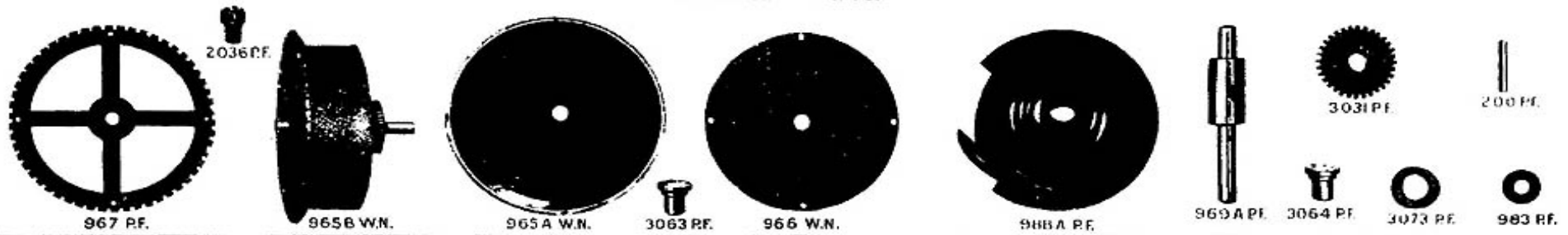

TURNTABLE GROUP

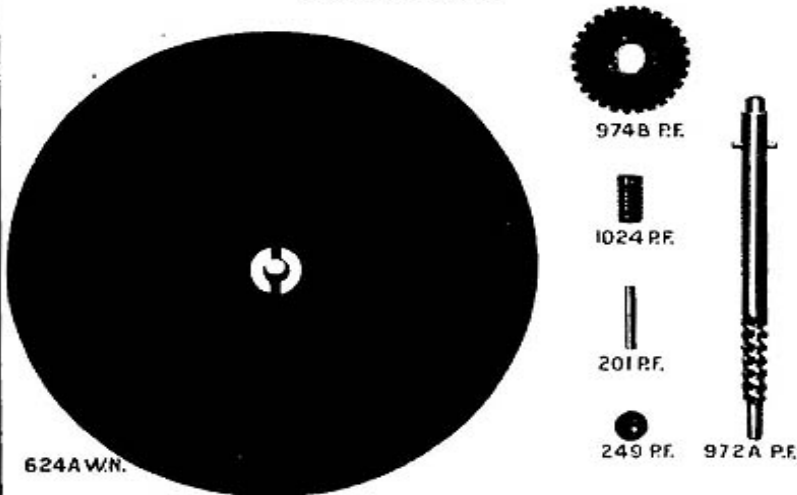

TOP PLATE GROUP

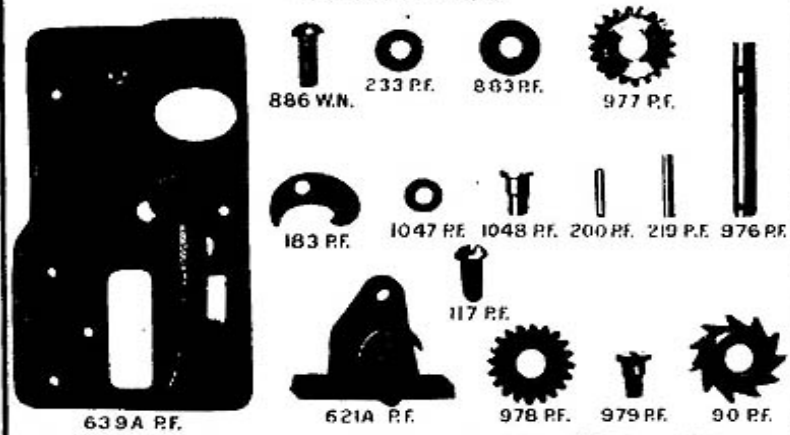

WINDING KEY GROUP

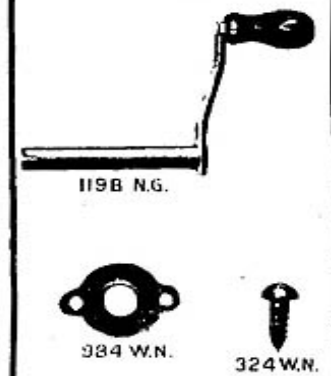

GOVERNOR GROUP

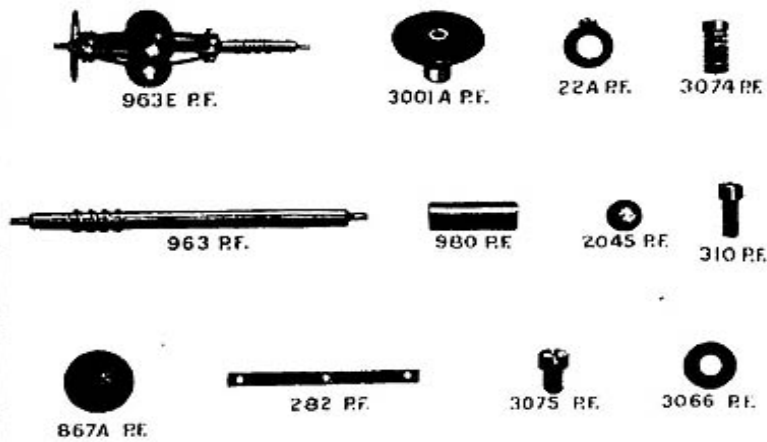

REGULATING AND BRAKE GROUP



HORN ARM GROUP

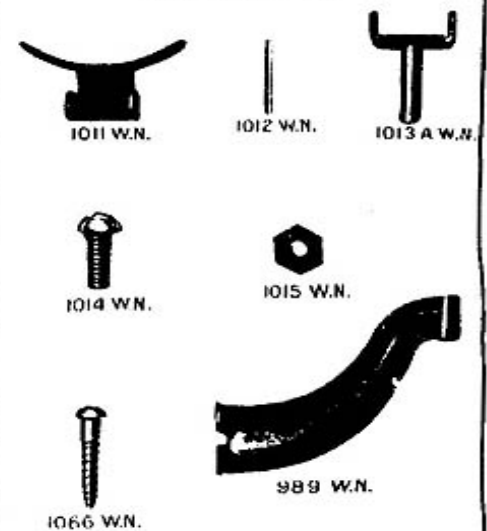

VICTOR XXV (Type M)

SPRING BARREL GROUP



TOP PLATE GROUP



GOVERNOR GROUP

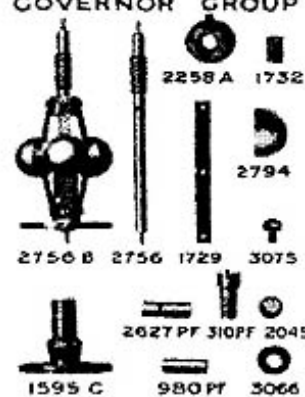

BRAKE GROUP

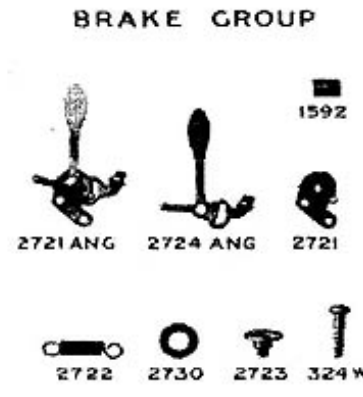

REGULATING GROUP

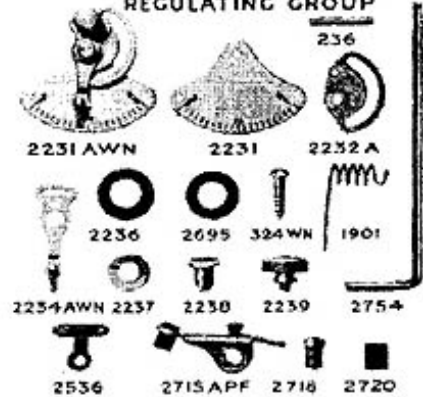

TAPER ARM GROUP

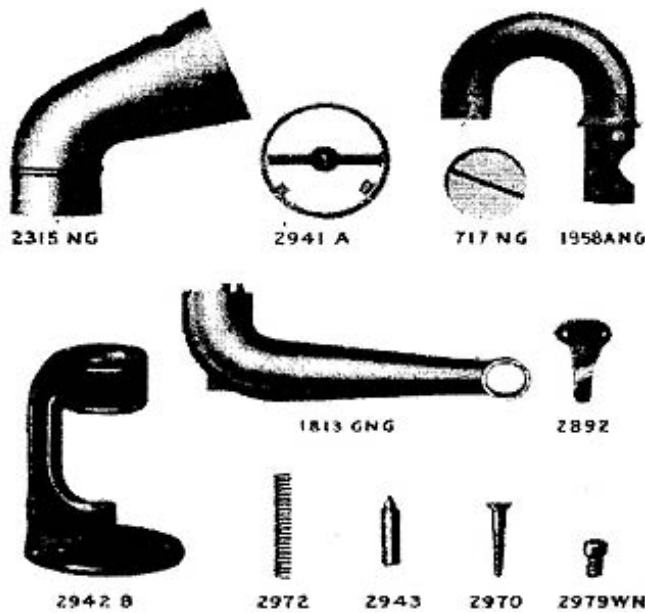

TURNTABLE GROUP

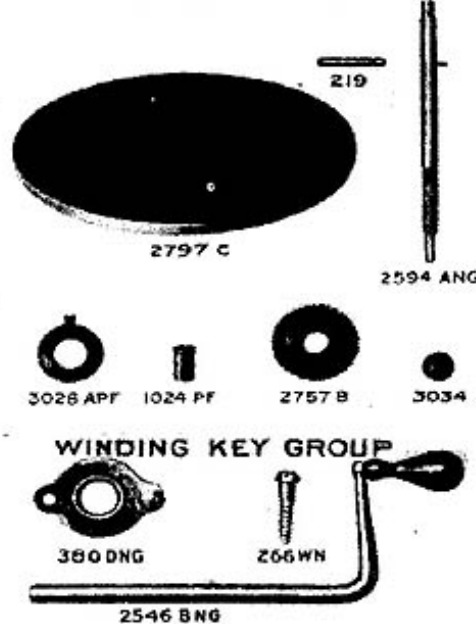

SUNDRY GROUP

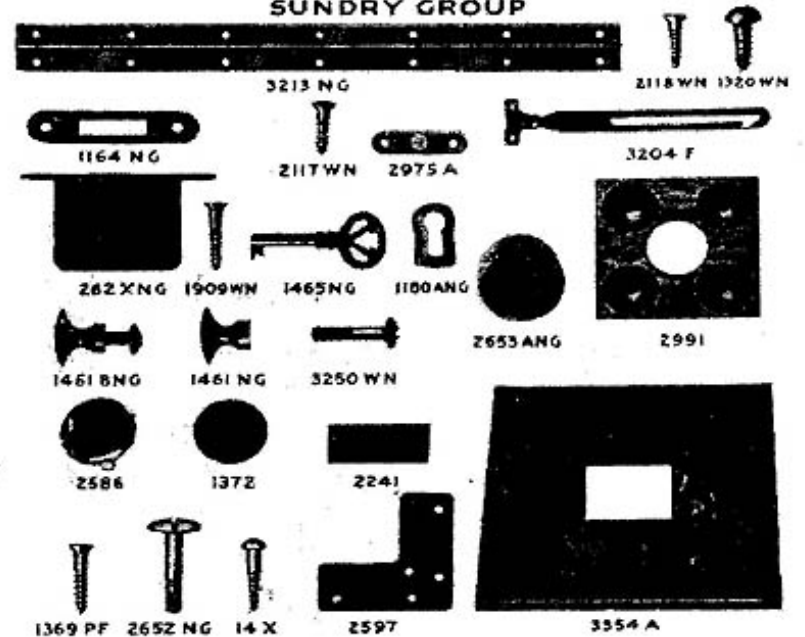

VICTOR VICTROLA IV (Type B)

SPRING BARREL GROUP

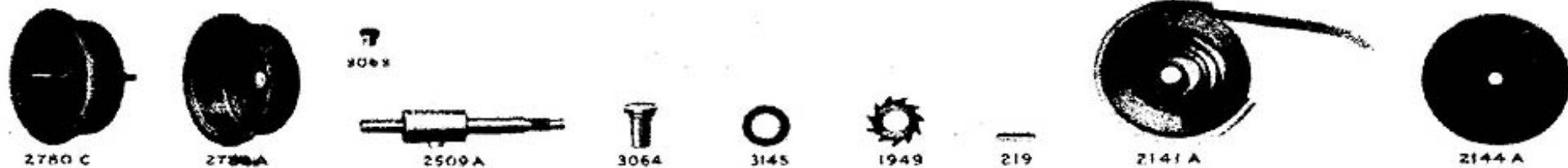

TOP PLATE GROUP

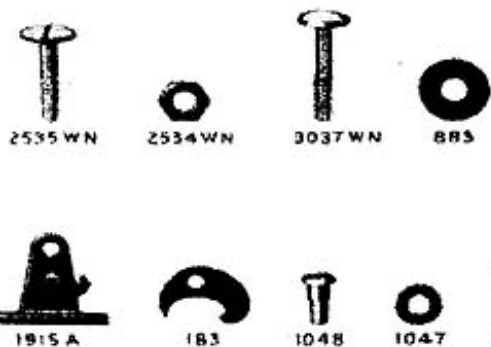

GOVERNOR GROUP

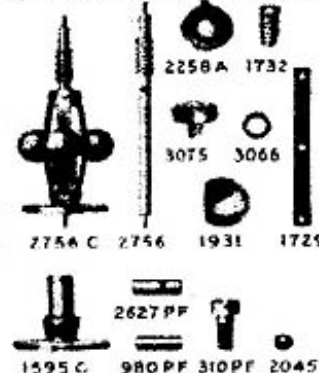

BRAKE GROUP

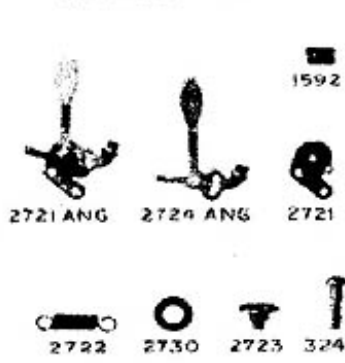

REGULATING GROUP



TAPER ARM GROUP

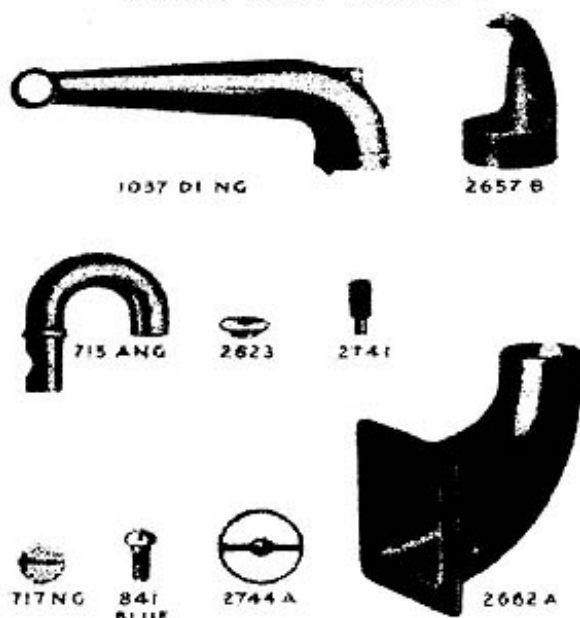

TURNTABLE GROUP

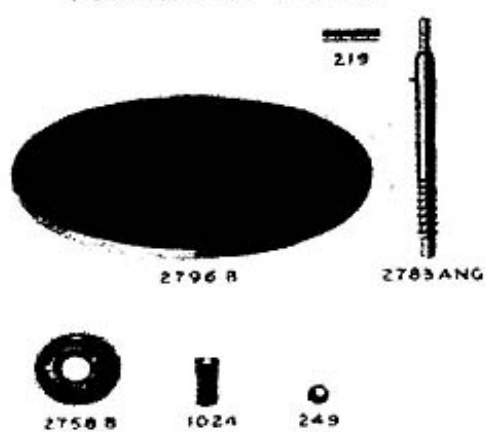

SUNDRY GROUP

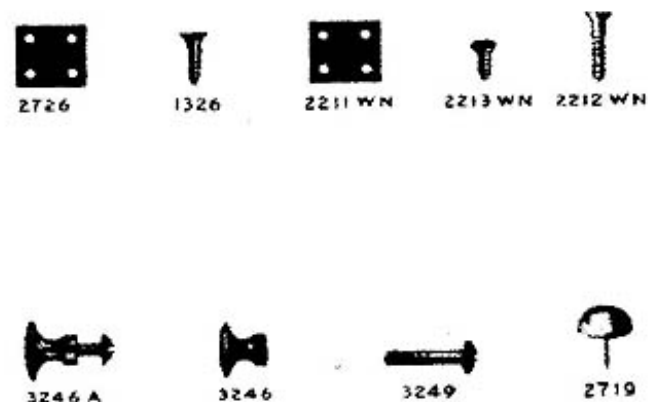

WINDING KEY GROUP



VICTOR-VICTROLA VI (Type F)

SPRING BARREL GROUP



3334 CWN



3334 BWN



3341 CWN



3341 BWN



3268 AWN

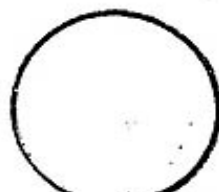

3692 WN



3667 APF



3336 APF



3063

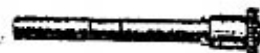

3342 APF

TOP PLATE GROUP



3540 AWN



2512 WN



3280 WN



3286 WN

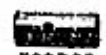

3887 PF



3861 APF



201 PF



3814 WN



2091 WN



3873 PF



3604 WN



3294 DPF



3476 PF

TAPER ARM GROUP

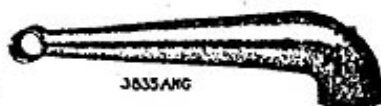

3835 ANG



3846 AL



715 ANG



717 NG



104 BUE



597 WN



3781 WN



3621 APF



586 WN



3622 AL

GOVERNOR GROUP

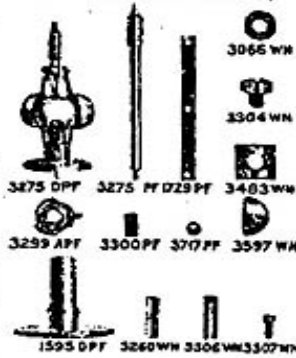

TURNTABLE GROUP

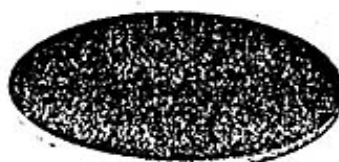

2797 MNG



219 PF



2758 BPF



1024 PF



3272 ANG



3034 PF

WINDING KEY GROUP



1320 WN

3344 GNG

3348 E8



3816 ANG



3349 NG

BRAKE GROUP



2721 ANG



2724 ANG



2721 WN



324 WN



2720 PF



2723 WN



2730 PF



2722 PF

REGULATING GROUP



3081 ANG



3798 ANG



324 WN



3288 APF



2717 PF



2718 PF



2720 PF



1901 PF

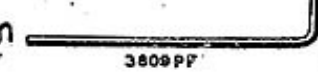

3809 PF

SUNDRY GROUP



1078 PF



1328 PF

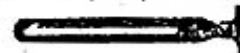

3675 ABP



1156 WN



2975 AWN



3661 WN



2657 WN



3689 AWN



3688 AWN



3694 AWN



3840 WN



2214 CO



324 WN



2719 PF

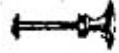

3247 BNG



3655 WR



3247 NG

VICTOR-VICTROLA X (Type J)

SPRING BARREL GROUP

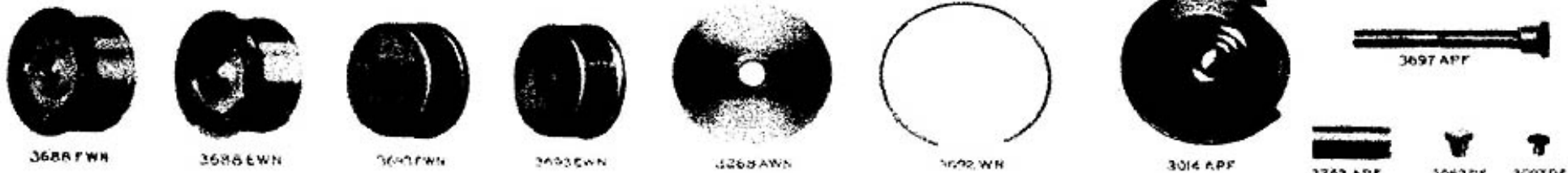

TOP PLATE GROUP

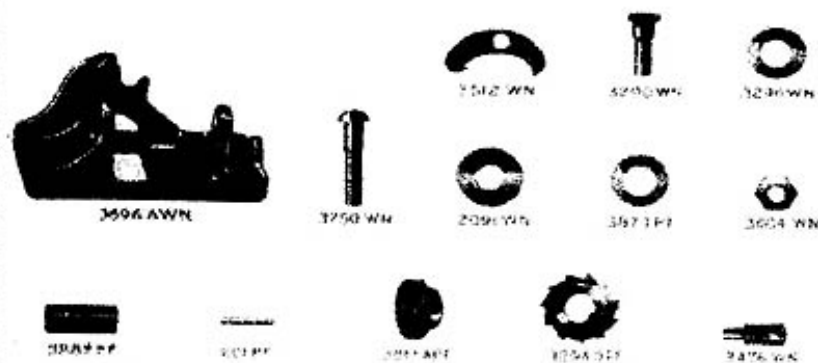

GOVERNOR GROUP

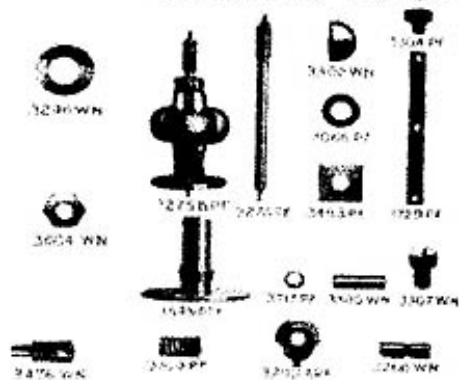

BRAKE GROUP

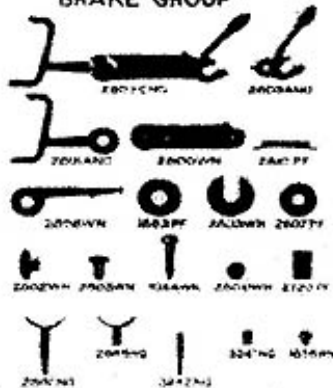

REGULATING GROUP

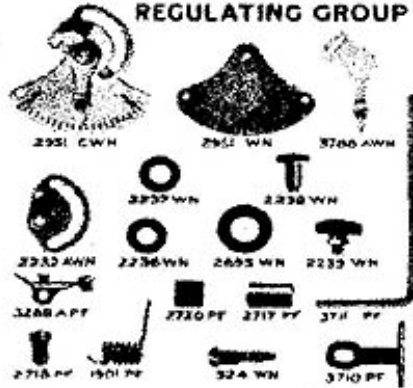

TAPER ARM GROUP

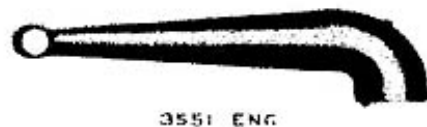

TURNTABLE GROUP

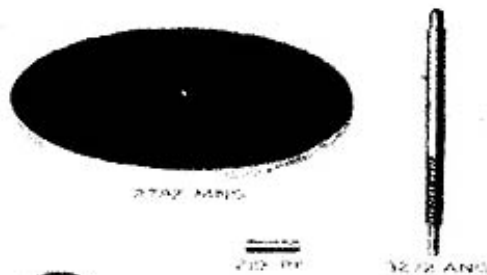

SUNDRY GROUP

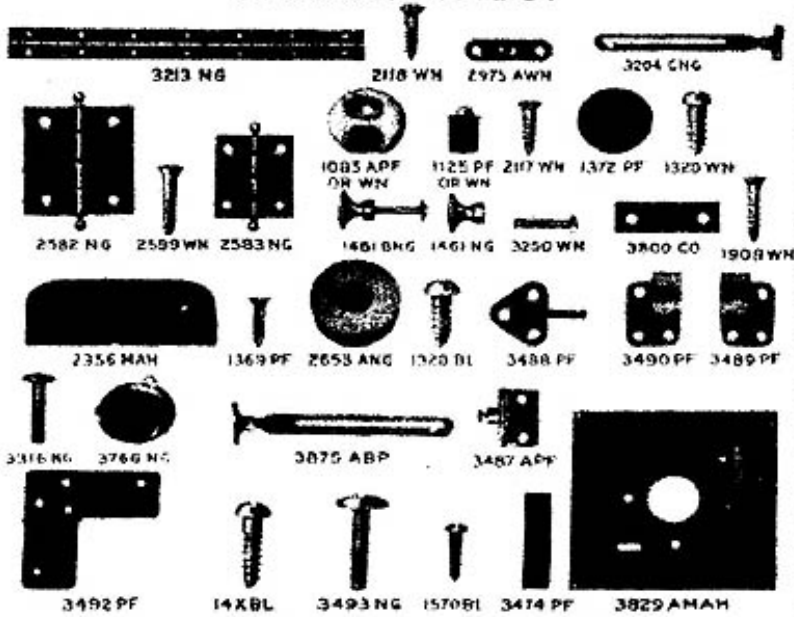

WINDING KEY GROUP



Victrola XII

